

## Accredited Lock Supply

Pemko Hinges consists of two full-height, paired and geared leaves. Each geared leaf rotates evenly from top to bottom riding on bearings. The geared leaves and bearings are held together by a full-length channel cap. This assembly retains the smooth, clean lines of the door and frame, while easily supporting heavy vertical loads. HD3 hinges are Grade 3 Heavy Duty, rated for up to 600 lbs. doors. HD1 hinges are Grade 1 Heavy Duty, up to 600 lbs. doors & 2.5 million door cycles.

### Full Surface Hinge

Full-surface units are designed mainly for retrofit work, and are applied to the exposed surface of the door and frame.

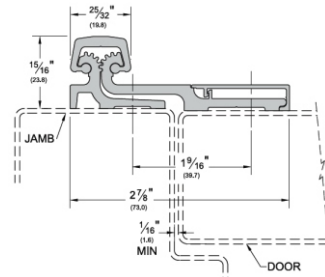

Part #	Length	Duty	Finish	Price
PKCFS83	83"	Standard	Aluminum	\$277.00
PKCFS83HD1	83"	Grade 1	Aluminum	\$348.00
PKDFS83	83"	Standard	Dark Bronze	\$352.00
PKDFS83HD1	83"	Grade 1	Dark Bronze	\$438.00
PKCFS95	95"	Standard	Aluminum	\$333.00
PKCFS95HD1	95"	Grade 1	Aluminum	\$415.00
PKDFS95	95"	Standard	Dark Bronze	\$422.00
PKDFS95HD1	95"	Grade 1	Dark Bronze	\$527.00

### Full Surface Hinge Center Pivot

Center pivot units easily replace butt hinges since no door or frame adjustments are necessary. Also, center pivot hinges are more versatile with restricted frame faces.

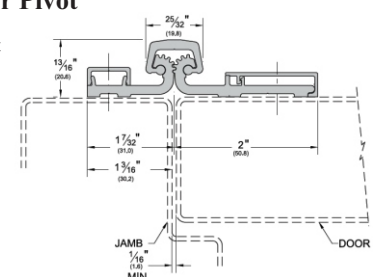

Part #	Length	Duty	Finish	Price
PKCFS83CP	83"	Standard	Aluminum	\$277.00
PKCFS83CPHD1	83"	Grade 1	Aluminum	\$348.00
PKDFS83CP	83"	Standard	Dark Bronze	\$352.00
PKDFS83CPHD1	83"	Grade 1	Dark Bronze	\$438.00
PKCFS95CP	95"	Standard	Aluminum	\$333.00
PKCFS95CPHD1	95"	Grade 1	Aluminum	\$415.00
PKDFS95CP	95"	Standard	Dark Bronze	\$422.00
PKDFS95CPHD1	95"	Grade 1	Dark Bronze	\$527.00

### Half Surface Hinge

Half-surface units are designed mainly for retrofit work, and are applied to the exposed surface of the door and the frame rabbet.

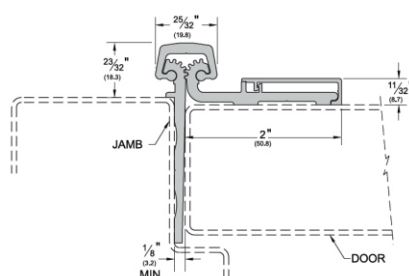

Part #	Length	Duty	Finish	Price
PKCHS83	83"	Standard	Aluminum	\$277.00
PKCHS83HD1	83"	Grade 1	Aluminum	\$348.00
PKDHS83	83"	Standard	Dark Bronze	\$352.00
PKDHS83HD1	83"	Grade 1	Dark Bronze	\$438.00
PKCHS95	95"	Standard	Aluminum	\$333.00
PKCHS95HD1	95"	Grade 1	Aluminum	\$415.00
PKDHS95	95"	Standard	Dark Bronze	\$422.00
PKDHS95HD1	95"	Grade 1	Dark Bronze	\$527.00

### Full Mortise Hinge

Full-mortise hinges are designed mainly for new door applications, and are applied so as to conceal both leaves.

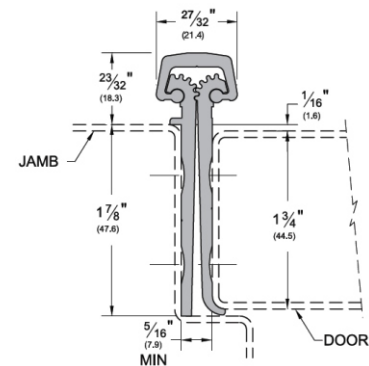

Part #	Length	Duty	Finish	Price
PKCFM83	83"	Standard	Aluminum	\$189.00
PKCFM83-HD1	83"	Grade 1	Aluminum	\$232.00
PKDFM83	83"	Standard	Dark Bronze	\$240.00
PKDFM83-HD1	83"	Grade 1	Dark Bronze	\$295.00
PKCFM95	95"	Standard	Aluminum	\$227.00
PKCFM95-HD1	95"	Grade 1	Aluminum	\$277.00
PKDFM95	95"	Standard	Dark Bronze	\$288.00
PKDFM95-HD1	95"	Grade 1	Dark Bronze	\$354.00

### Markar

#### Full Surface 1/8" Offset, Pin and Barrel

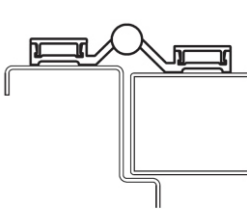

**FS101**

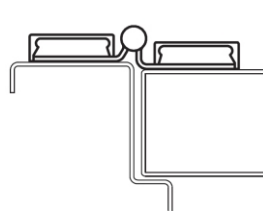

**FS201  
FS301**

Part #	Length	Material	Finish	Price
<b>MRFS101-7-BRZ</b>	7'	Aluminum	Duranodic	\$955.00
<b>MRFS101-8-AL</b>	8'	Aluminum	Aluminum	\$908.00
<b>MRFS101-8-BRZ</b>	8'	Aluminum	Duranodic	\$1,108.00
<b>MRFS201-7-P</b>	7'	Carbon Steel	Prime Coat	\$642.00

#### Full Surface Flush

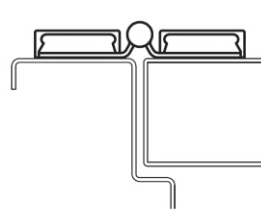

**FS102**

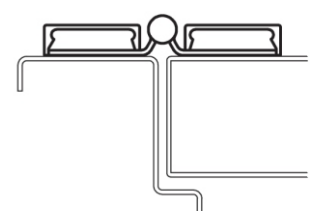

**FS202  
FS302**

Part #	Length	Material	Finish	Price
<b>MRFS102-7-AL</b>	7'	Aluminum	Aluminum	\$782.00
<b>MRFS102-7-BRZ</b>	7'	Aluminum	Duranodic	\$955.00
<b>MRFS102-8-BRZ</b>	8'	Aluminum	Duranodic	\$1,108.00
<b>MRFS202-7-P</b>	7'	Carbon Steel	Prime Coat	\$642.00

#### Edge Mount

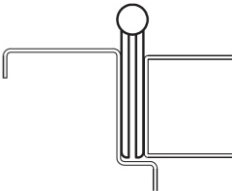

**FM100**

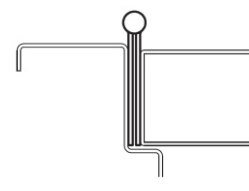

**FM200**

Part #	Length	Material	Finish	Price
<b>MRFM100-7-AL</b>	7'	Aluminum	Aluminum	\$644.00
<b>MRFM200-7-P</b>	7'	Carbon Steel	Prime Coat	\$506.00

#### Half Surface

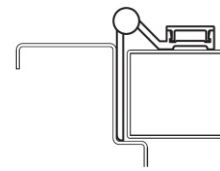

**HS103**

Part #	Length	Material	Finish	Price
<b>MRHS103-7-BRZ</b>	7'	Aluminum	Duranodic	\$931.00

#### Full Surface Reinforcing Pivots

This full-surface reinforcing pivot adds years of life to openings where the hinges or hingereinforcements have failed. An economical way to solve door sag problems, reinforcing pivots take the load off the top hinge and transfer it to screws that will not pull out.

Capacity:  
Supports Weights up to 300 lbs.

Hole Pattern:  
Symmetrically

Handing:  
Non-handed

**ADB1923**

\$99.00

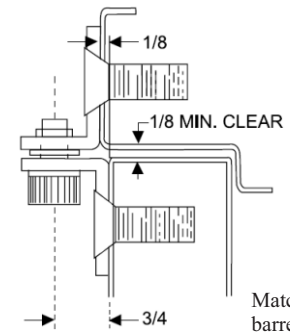
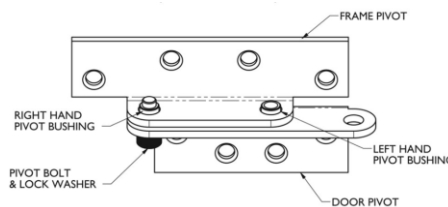

Matches 4-1/2" barrel centerline